

Brass & Bronze Valves and Strainers

Figure BGA – Brass Gate Valve

- Non-rising stem
- Screwed ends – BSP Parallel
- Pressure rating 1600 kPa W.O.G.

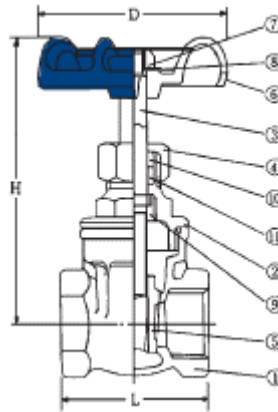

No.	Part	Material
1	Body	Forged Brass
2	Bonnet	Forged Brass
3	Stem	Forged Brass
4	Packing Nut	Brass
5	Disc	Forged Brass
6	Hand Wheel	Cast Iron
7	Wheel Nut	Brass
8	Name Plate	Aluminium
9	Lock Washer	Brass
10	Gland	Brass
11	Gland Packing	PTFE

Size mm		8	10	15	20	25	32	40	50	65	80	100
End to End	L	40	42	48.5	51	59.5	59.5	63	69	88	95	114
Centre to Top	H	61.5	61.5	72.1	76.7	87.6	103	113.7	147.7	163.5	190	235
Wheel Dia.	D	45	45	55	55	60	72	72	80	100	110	130

Figure BRGA – Bronze Gate Valve

- Non-rising stem
- Screwed ends – BSP Parallel
- Pressure rating 1400 kPa W.O.G.

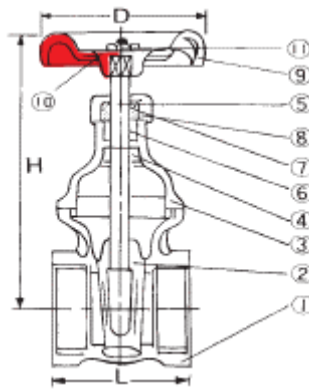

No.	Part	Material
1	Body	Cast Bronze
2	Disc	Cast Bronze
3	Bonnet	Cast Bronze
4	Lock Nut	Brass
5	Stem	Brass
6	Packing	Non-Asbestos
7	Gland	Brass
8	Packing Nut	Brass
9	Handwheel	Cast Iron
10	Name Plate	Aluminium
11	Wheel Nut	Zinc Plate Carbon Steel

Size mm		10	15	20	25	32	40	50	65	80	100
End to End	L	42	42	50	54	60	65	71	88	96	115
Centre to Top	H	85	85	94	105	125	140	155	200	220	270
Wheel Dia.	D	55	55	63	63	80	80	90	110	125	140

Figure BCH – Swing Check Valve

- Screwed ends – BSP Parallel
- Pressure rating 1400 kPa W.O.G.

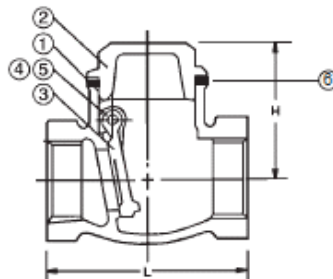

No.	Part	Material
1	Body	Cast Brass
2	Cap	Cast Brass
3	Disc	Cast Brass
4	Hinge Pin	Brass Rod
5	Hex Plug	Brass Rod
6	Gasket	Compressed Fibre

Size mm		10	15	20	25	32	40	50	65	80	100
End to End	L	54	56	61	68	78	91	105	130	141	169
Centre to Top	H	35	36	40	44	52	60	66	78	83	100

Free call: 1300 55 34 73

Web: www.antec.com.au

Email: anteceng@antec.com.au

NSW (Head Office)

9 Chicago Avenue
Blacktown NSW 2148
P: +61 2 9622 9622
F: +61 2 9622 9199

VICTORIA

90 Turner Street
Port Melbourne VIC 3207
P: +61 3 8645 3222
F: +61 3 9646 7945

QUEENSLAND

5/429 Creek Road
Mt Gravatt QLD 4122
P: +61 7 3420 0890
F: +61 7 3420 4033

SOUTH AUSTRALIA

70 Grand Junction Road
Kilburn SA 5084
P: +61 8 8304 7543
F: +61 8 8304 7544

WESTERN AUSTRALIA

2/17 Baile Road
Canning Vale WA 6155
P: +61 8 6350 9600
F: +61 8 6350 9601

Brass & Bronze Valves and Strainers

Figures B84 & B84P – Ball Valves

- B84: Screwed Ends – BSP Taper, Yellow Handle
- B84P: Screwed Ends – BSP Parallel, Black Handle
- Features:
 - Robust construction
 - 100% tested
 - Blow out proof stem
 - O-Ring Stem Seal
 - Temperature Range: -20°C + 170°C
 - Lockable Handle Option
- Materials:
 - Body: Nickel Plated Brass
 - Ball: Chrome Plated Brass
 - Seats: G/F PTFE
 - Stem Seals: Viton O-Rings
 - Handles: Dacrotised Steel with PVC Sleeve

Pressure – Temperature Chart

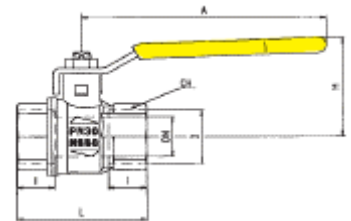
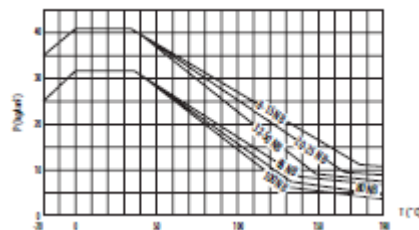

D(Size mm)	8	10	15	20	25	32	40	50	65	80	100
DN	8	10	15	20	25	32	40	50	64	76	95
I	12	12	16	17	21	23	23	27	32	35	42
L	45	45	59	64	81	93	102	121	156	177	216
A	82	82	100	120	120	158	158	158	255	255	255
H	38	38	43	50	54	73	79	86	132	140	154
CH	20	20	25	31	40	49	54	68	85	99	125
kPa	4100	4100	4100	4100	4100	4100	4100	4100	3100	3100	3100

Figures B34T – Mini Ball Valve

- Mini Ball Features
 - Compact T-Handle Design
 - Size Range: 6-15mm
 - Chrome Plated Brass Body & Ball
 - PTFE Seats
 - Viton O-Ring Seals
 - Max. CWP 1500 kPa
 - Max. Temp. 90°C
 - F&F (Model B34T) or M&F (model B34TMF) Options



Dimensions (mm) approximate

Size	6	8	10	15
Length	41	41	41	49
Height	21	21	21	25

Patented Lockable Handle

- To fit all Turnflo 8-50mm forged valves
- Made of strong dacrotised steel, the locking device covers the top nut of the valve, making removal impossible without removing the padlock.
- Easy to install in the field, this handle will lock in open or closed position.



Product Code*	Valve Size mm
119809	8-15mm
119810	20-25mm
119811	32-50mm

*Use 7mm padlock all sizes. (Not Supplied).

Free call: 1300 55 34 73

Web: www.anteccom.au

Email: anteceng@anteccom.au

NSW (Head Office)

9 Chicago Avenue
Blacktown NSW 2148
P: +61 2 9622 9622
F: +61 2 9622 9199

VICTORIA

90 Turner Street
Port Melbourne VIC 3207
P: +61 3 8645 3222
F: +61 3 9646 7945

QUEENSLAND

5/429 Creek Road
Mt Gravatt QLD 4122
P: +61 7 3420 0890
F: +61 7 3420 4033

SOUTH AUSTRALIA

70 Grand Junction Road
Kilburn SA 5084
P: +61 8 8304 7543
F: +61 8 8304 7544

WESTERN AUSTRALIA

2/17 Baile Road
Canning Vale WA 6155
P: +61 8 6350 9600
F: +61 8 6350 9601

Brass & Bronze Valves and Strainers

Figure B100S Ball Valve

- Features:
 - 100% Pressure Tested
 - Full Port
 - Generous Thread Depth
 - Screwed Ends – BSP Parallel
 - Also available Fig B100S-MF (15-25mm) screwed M&F
- Materials:
 - Body: Nickel Plated Brass
 - Ball: Chrome Plated Brass
 - Seats: PTFE
 - Stem Seals: 15-50mm NBR O’ring / 65-100mm PTFE Packing gland
 - Handle: Stainless steel with plastic sleeve

Pressure – Temperature Chart

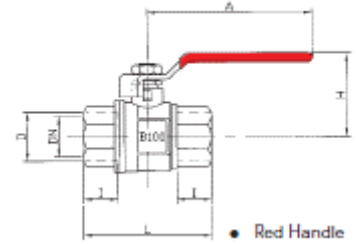
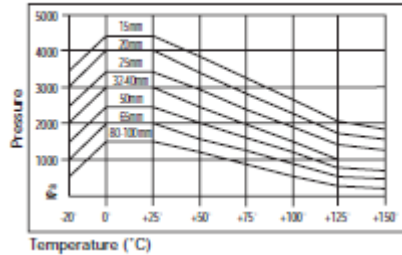

Dimensions (mm)

Size (mm)	15	20	25	32	40	50	65	80	100
I	16.5	18	20.5	23.5	23.5	28	28.8	28.8	36.6
L	60	67.5	80	96.5	105.5	139.6	139.6	151.8	188.2
A	93	112	113	130	162	230	230	230	230
H	45.7	50	54	65.5	90	115	115	123	135

Figures BYS – Y-Strainer

- Body, Cover & Plug – Bronze to ASTM B62
- Screen – 20 Mesh Stainless Steel
- Gasket – Silicone Rubber
- Screwed Bonnet
- Screwed Ends – BSP Parallel
- Pressure & Temperature Rating:
 - Steam: 2100 kPa @ 232°C
 - Water, Oil, Gas: 2700kPa @ 66°C

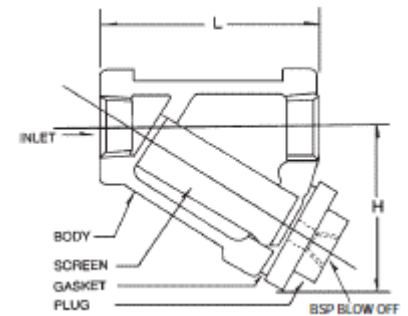

Size mm	15	20	25	32	40	50
L	75	88	103	125	147	170
H	49	56.5	69.5	87	99	121.5

Size range 15-50 mm

Antec provides the information contained in this brochure as a guide only for your information. Antec has taken reasonable care to ensure the accuracy of the material but you should not rely on the whole or part of the information. Antec expressly disclaims all liability whatsoever for (including any direct or indirect loss or damage, costs or expenses howsoever incurred by any person) or reliance on the whole or part of the information contained in or omitted from this brochure. Antec recommends that you verify any information regarding products with your independent expert adviser and rely solely on that adviser’s recommendations.

Free call: 1300 55 34 73

Web: www.antec.com.au

Email: anteceng@antec.com.au

NSW (Head Office)

9 Chicago Avenue
Blacktown NSW 2148
P: +61 2 9622 9622
F: +61 2 9622 9199

VICTORIA

90 Turner Street
Port Melbourne VIC 3207
P: +61 3 8645 3222
F: +61 3 9646 7945

QUEENSLAND

5/429 Creek Road
Mt Gravatt QLD 4122
P: +61 7 3420 0890
F: +61 7 3420 4033

SOUTH AUSTRALIA

70 Grand Junction Road
Kilburn SA 5084
P: +61 8 8304 7543
F: +61 8 8304 7544

WESTERN AUSTRALIA

2/17 Baile Road
Canning Vale WA 6155
P: +61 8 6350 9600
F: +61 8 6350 9601