

For Non-Health Hazard Applications

Job Name _____
 Job Location _____
 Engineer _____
 Approval _____

Contractor _____
 Approval _____
 Contractor's P.O. No. _____
 Representative _____

Series 007

Double Check Valve Assemblies

Sizes: 1/2" – 3" (15 – 80mm)

Series 007 Double Check Valve Assemblies shall be installed at referenced cross-connections to prevent the backflow of polluted water into the potable water supply. Only those cross-connections identified by local inspection authorities as non-health hazard shall be allowed the use of an approved double check valve assembly.

Check with local authority having jurisdiction regarding vertical orientation, frequency of testing or other installation requirements.

The valve shall meet the requirements of ASSE Std. 1015 and AWWA Std. C510. Approved by the Foundation for Cross-Connection Control and Hydraulic Research at the University of Southern California.

Features

- Ease of maintenance — only one cover
- Top entry
- Replaceable seats and seat discs
- Modular construction
- Compact design
- Cast bronze body construction — 1/2" – 2" (15 – 50mm)
- Fused epoxy coated cast iron body — 2 1/2" – 3" (65 – 80mm)
- Top mounted ball valve test cocks
- Low pressure drop
- No special tools required for servicing
- 1/2" – 1" (15 – 25mm) have tee handles

Specifications

A Double Check Valve Assembly shall be installed at each noted location. The assembly shall consist of two positive seating check modules with captured springs and rubber seat discs. The check module seats and seat discs shall be replaceable. Service of all internal components shall be through a single access cover secured with stainless steel bolts. The assembly shall also include two resilient seated isolation valves; four top mounted, resilient seated test cocks. The assembly shall meet the requirements of ASSE Std. 1015 and AWWA Std. C510. Approved by the Foundation for Cross-Connection Control and Hydraulic Research at the University of Southern California. Assembly shall be a Watts Regulator Company Series 007.

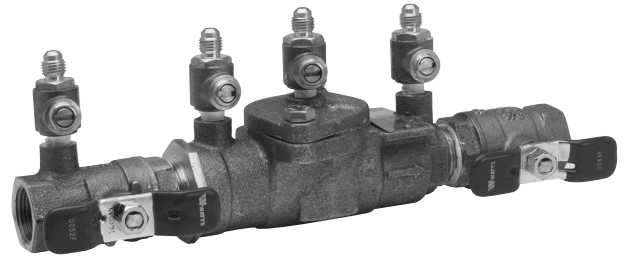

3/4" (20mm) 007M3QT

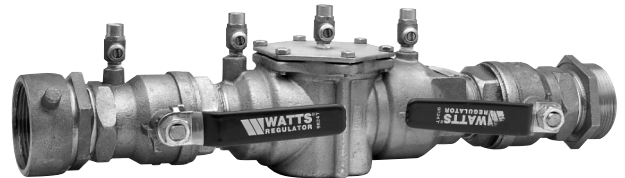

2" (50mm) 007M1QT HC

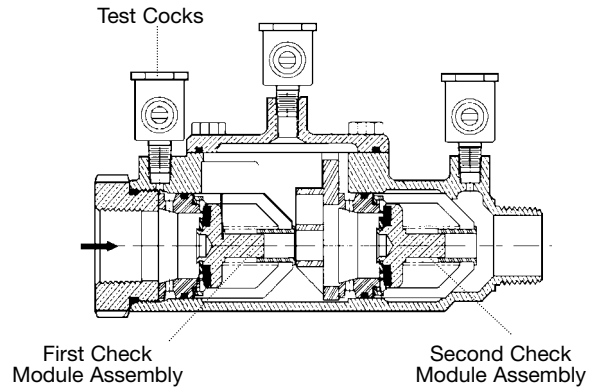

The 007 Series features a modular design concept which facilitates complete maintenance and assembly by retaining the spring load.

Now Available
WattsBox Insulated Enclosures.
 For more information, send for literature ES-WB.

IMPORTANT: INQUIRE WITH GOVERNING AUTHORITIES FOR LOCAL INSTALLATION REQUIREMENTS

Watts product specifications in U.S. customary units and metric are approximate and are provided for reference only. For precise measurements, please contact Watts Technical Service. Watts reserves the right to change or modify product design, construction, specifications, or materials without prior notice and without incurring any obligation to make such changes and modifications on Watts products previously or subsequently sold.



Pressure – Temperature

½" – 2" (15 – 50mm)

Temperature Range: 33°F – 180°F (0.5°C – 82°C).

Maximum Working Pressure: 175psi (12.1 bar).

2½" – 3" (65 – 80mm)

Temperature Range: 33°F – 110°F (0.5°C – 43°C) continuous, 140°F (60°C) intermittent.

Maximum Working Pressure: 175psi (12.1 bar).

Standards

ASSE Std. 1015, AWWA Std. C510

IAPMO PS31, CSA B64.5

Approvals



† ASSE, AWWA, IAPMO, CSA, UPC

▲ Approved by the Foundation for Cross-Connection Control and Hydraulic Research at the University of Southern California.

- Models LF and S are not listed.
- ◆ UL Classified (LF models only) ¾" – 2" (20 – 50mm) (except 009M3LF)
- ◆ UL Classified with OSY gate valves (2½" and 3" horizontal only.)
- * Horizontal approval on all sizes.

Suffix:

S - bronze strainer

LF - without shutoff valves

LH - locking handle ball valves (open position)

SH - stainless steel ball valve handles

HC - 2½" inlet/outlet fire hydrant fittings (2" valve)

Prefix:

U - Union connections

2½" – 3" (65 – 80mm)

Suffix:

NRS - non-rising stem resilient seated gate valves

OSY - UL/FM outside stem and yoke resilient seated gate valves

LF - without shutoff valves

QT-FDA - FDA epoxy coated quarter-turn ball valves

Dimensions – Weights

Models

Sizes: ½" – 2" (15 – 50mm)

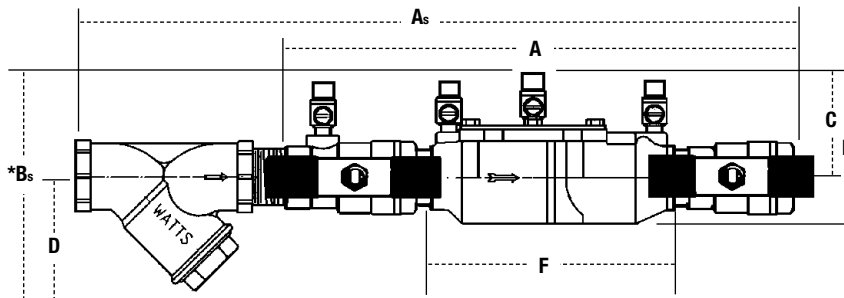

*Subscript 'S' = strainer model

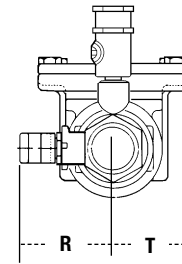

Suffix HC — Fire Hydrant Fittings dimension "A" = 23½" (594mm)

MODEL	SIZE (DN)		DIMENSIONS										WEIGHT							
	in.	mm	A		B		C		D		F		G		R		T		lbs.	kgs.
†▲007QT	½	15	10	254	4⅝	117	2⅞	62	—	—	5	127	3⅝	85	2⅝	59	2⅞	52	4.5	2
†▲007M3QT	¾	20	11⅝	282	4	102	3⅝	79	—	—	6⅜	157	3⅞	87	2⅞	54	1⅞	33	5	2.3
†▲007M1QT	1	25	13¼	337	5⅞	130	4	102	—	—	7½	191	3⅝	85	1⅞	43	1⅞	43	12	5.4
†▲007M2QT	1¼	32	16⅝	416	5	127	3⅞	84	—	—	9½	241	5	127	3	76	2	50	15	6.8
†▲007M2QT	1½	40	16¾	425	4⅞	124	3½	89	—	—	9¾	248	5⅞	148	3⅞	79	2⅞	68	15.9	7.2
†▲007M1QT	2	50	19½	495	6¼	159	4	102	—	—	13⅝	340	6⅞	156	3⅞	87	2⅞	68	25.7	11.7
• 007QT-S	½	15	13	330	6	152	2⅞	62	3	76	5	127	3⅝	85	2⅝	59	2⅞	52	5.5	2.5
• 007M3QT-S	¾	20	14½	368	6⅞	156	3⅞	79	3	76	6⅜	157	3⅞	87	2⅞	54	1⅞	33	6.7	3.1
• 007M1QT-S	1	25	17⅞	157	7¾	197	4	102	3¼	83	7½	191	3⅝	85	1⅞	43	1⅞	43	14	6.4
• 007M2QT-S	1¼	32	21½	546	7⅞	179	3⅞	84	3½	83	9½	241	5	127	3	76	2	50	19	8.6
• 007M2QT-S	1½	40	25⅞	637	7⅞	179	3½	89	3¾	95	9¾	248	5⅞	148	3⅞	79	2⅞	68	19.6	8.9
• 007M1QT-S	2	50	27¼	692	8¾	222	4	102	4	102	13⅝	340	6⅞	156	3⅞	87	2⅞	68	33.5	15.2

Dimensions – Weights

Sizes: 2½" – 3" (65 – 80mm)

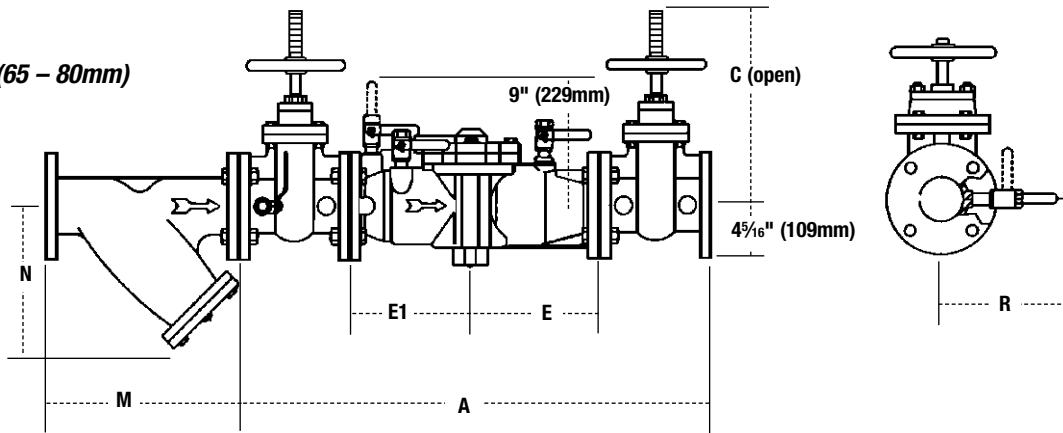

MODEL	SIZE (DN)		DIMENSIONS						WEIGHT			
	in.	mm	A		C		E, E1		R		lbs.	kgs.
007QT-FDA	2½	65	33⅞	841	6⅜	162	9¼	230	8¾	222	155	70
▲ 007-NRS	2½	65	33⅞	841	9⅜	238	9¼	230	8¾	222	155	70
▲◆ 007-OSY	2½	65	33⅞	841	16⅜	416	9¼	230	8¾	222	158	72
007-QT-FDA	3	80	34⅞	867	6⅜	162	9¼	230	8¾	222	155	70
▲◆ 007-NRS	3	80	34⅞	867	10¼	260	9¼	230	8¾	222	185	84
▲ 007-OSY	3	80	34⅞	867	18⅞	479	9¼	230	8¾	222	185	84

Strainer Dimensions

SIZE				WEIGHT			
		M		N			
in.	mm	in.	mm	in.	mm	lbs.	kgs.
2½	65	10	254	6½	165	28	13
3*	80	10⅞	267	7	178	34	15

*S Models only

1" U007M1QT

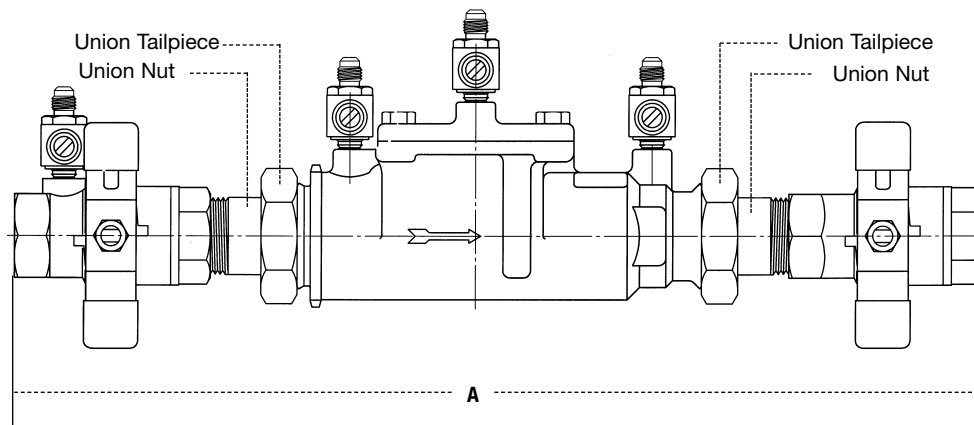

Sizes: ½" – 2" (15 – 50mm)

MODEL	SIZE (DN)		DIMENSIONS	
	in.	mm	A	
	in.	mm	in.	mm
U007QT	½	15	12¼	326
U007M2QT	¾	20	13¼	350
U007M2QT	1	25	16⅝	422
U007M2QT	1¼	32	20¾	527
U007M2QT	1½	40	21½	546
U007M1QT	2	50	24½	622

Capacity

As compiled from documented Foundation for Cross-Connection Control and Hydraulic Research at the University of Southern California lab tests.

* Typical maximum system flow rate (7.5 feet/sec., 2.3 meters/sec.)

** UL rated flow

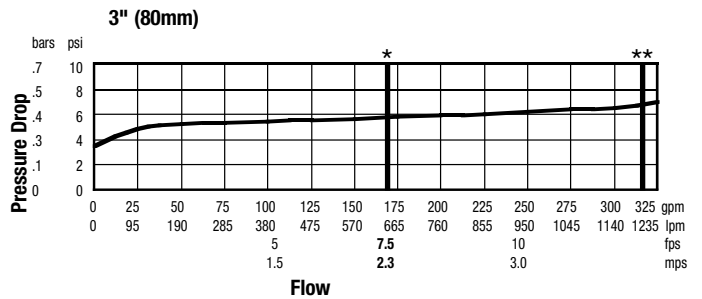
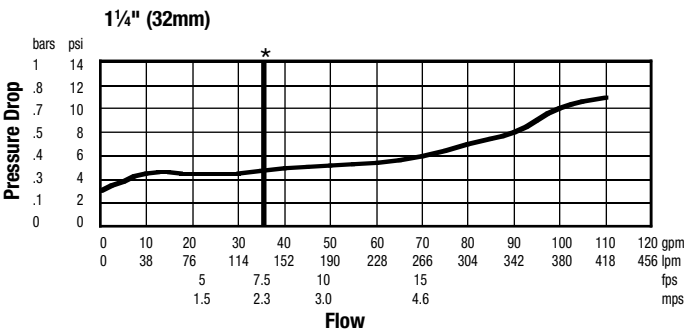
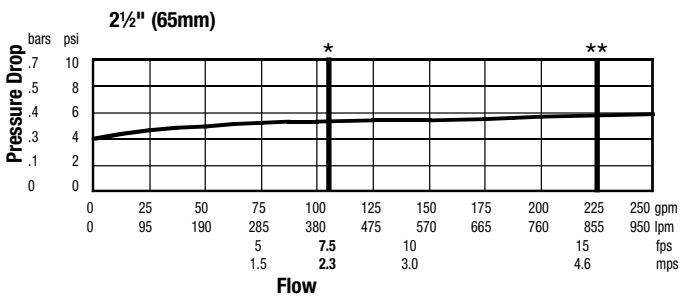
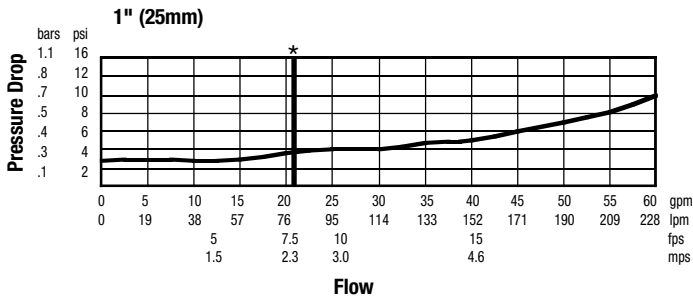
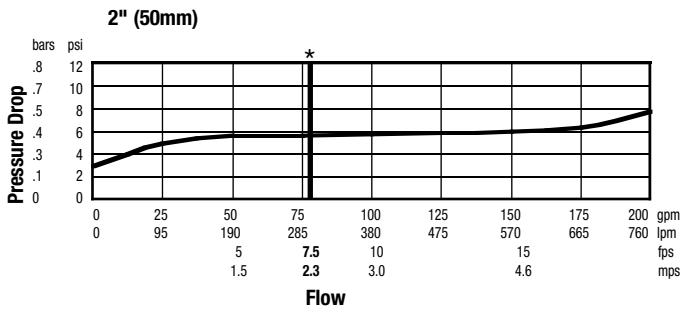
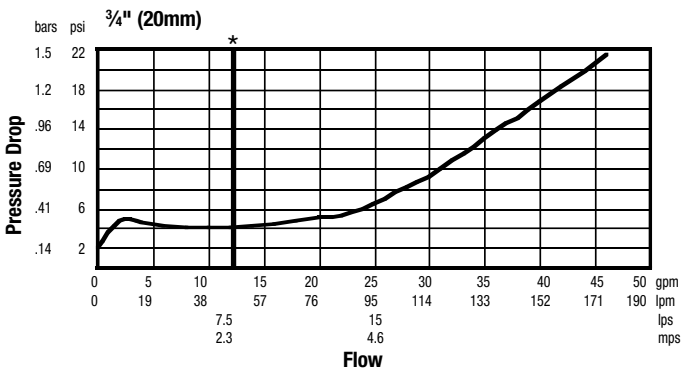
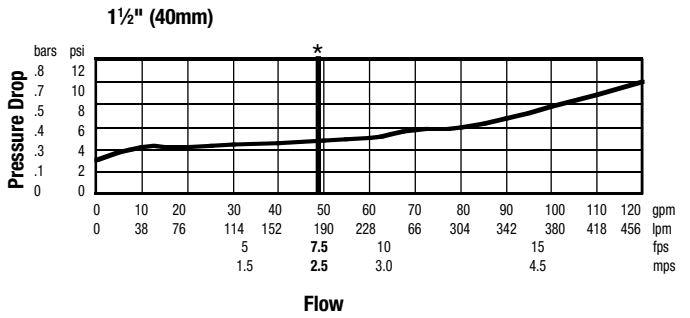
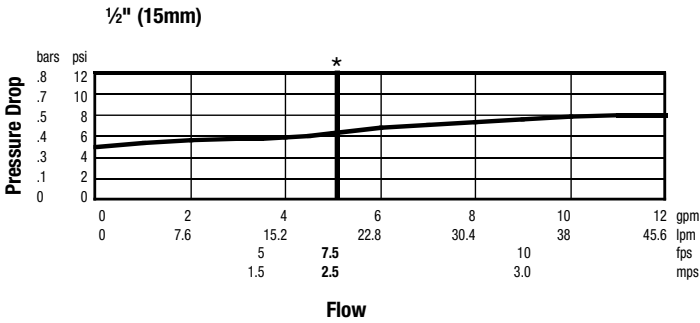

Backflow Prevention Products



USA: 815 Chestnut St., No. Andover, MA 01845-6098; www.watts.com
 Canada: 5435 North Service Rd., Burlington, ONT. L7L 5H7; www.wattscanada.ca